

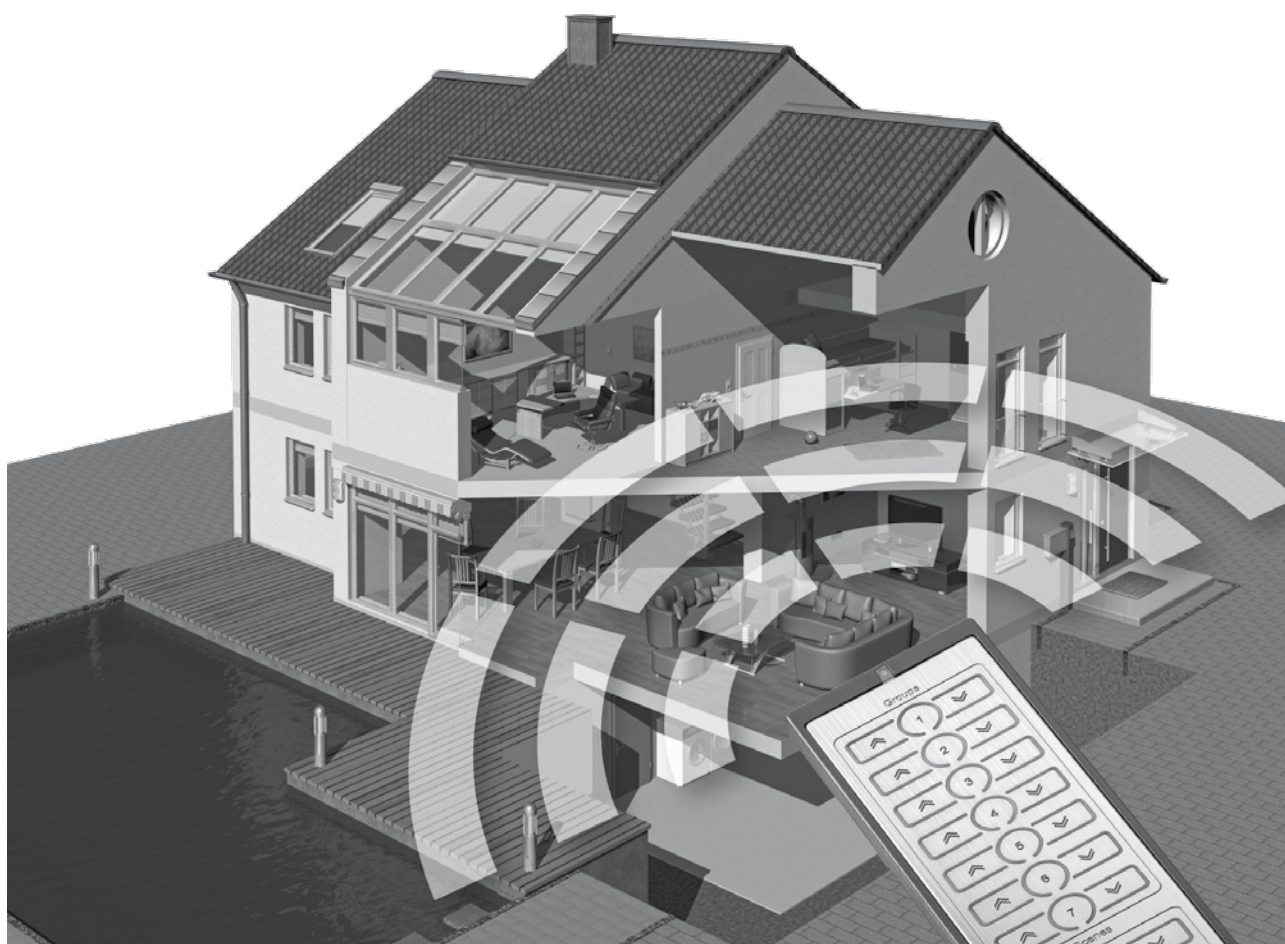

WIRELESS FLUSH MOUNTED SWITCH ZW ES 1000

GB

User manual for art. no. 05431³

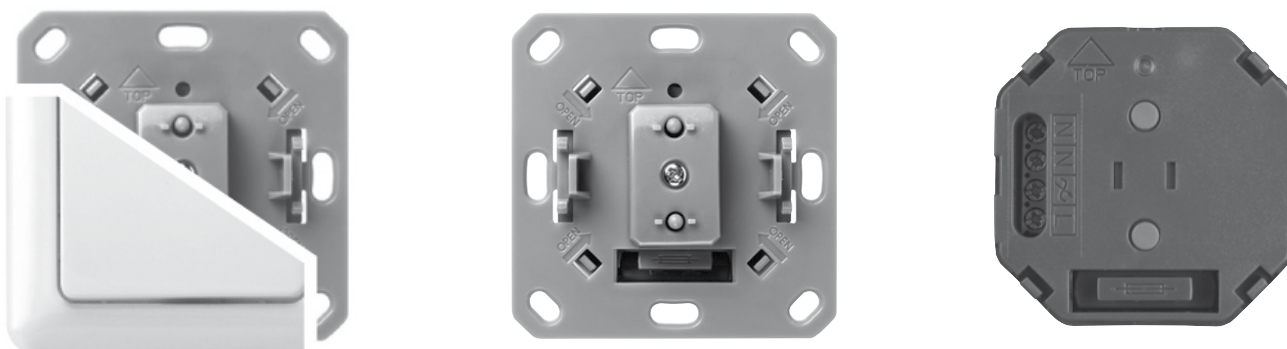

WIRELESS SYSTEM Z-WAVE

TECHNICAL DATA

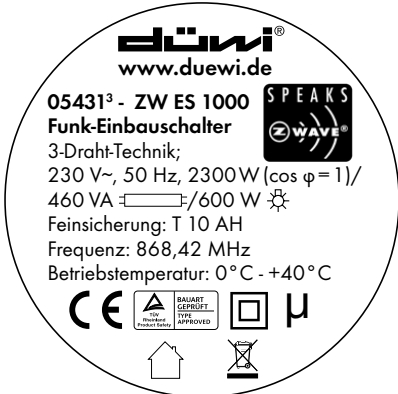

- Operating voltage: 230V~, 50Hz
- Switching capacity: 2,300W Ohmic load
460VA Inductive load
600W Capacitive load for appliances and lights
- Fine-wire fuse: T 10 AH
- Transmitting/receiving frequency: 868.42 MHz
- Operating temperature: 0° - +40 °C
- Dimensions (H x W x D) 52 x 52 x 31 mm (without support ring)
71 x 71 x 42 mm (with support ring)

Can be integrated in the following switch series:



CIRCUIT DIAGRAM

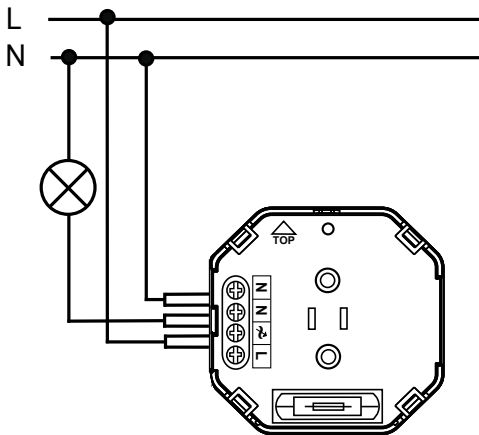

PRODUCT DETAILS

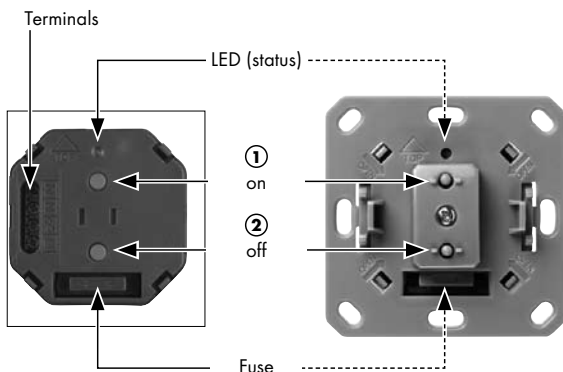

The flush mounted modules have 2 function buttons (①/②), for On/Up (short press) and Off/Down (long press) on the button/rocker. The flush mounted modules completed with support ring and dūwi wireless rocker operate as electronic actuators (switches) that can be operated both mechanically and wirelessly.

INSTALLATION

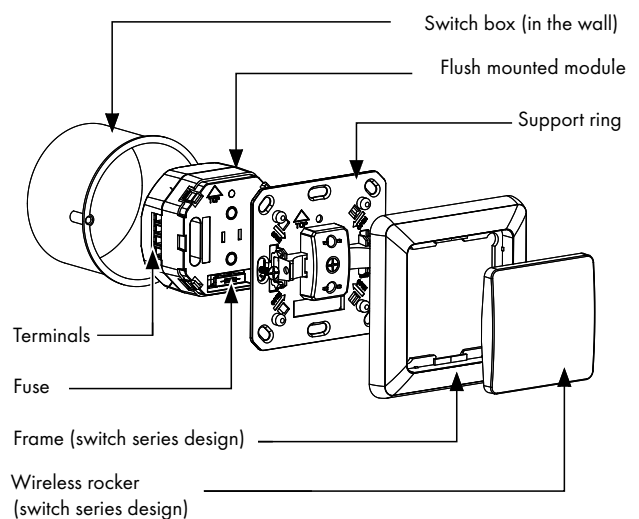

FUNCTION BUTTONS ON THE düwi CONTROLLER

düwi remote control
art. no. 05445⁰

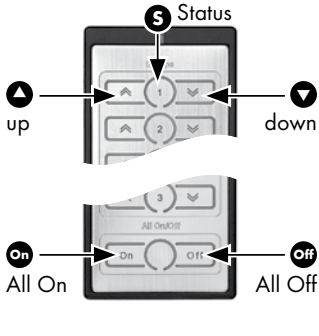

düwi wireless wall transmitter
art. no. 05443⁶

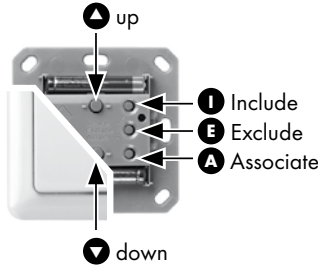

düwi wireless switching-centre
art. no. 05447⁴



FUNCTION BUTTONS ON THE düwi RECEIVER

düwi wireless flush mounted switch, art. no. 05431³
düwi wireless flush mounted dimmer 300W, art. no. 05433⁷
düwi wireless flush mounted shutter switch, art. no. 05436⁸

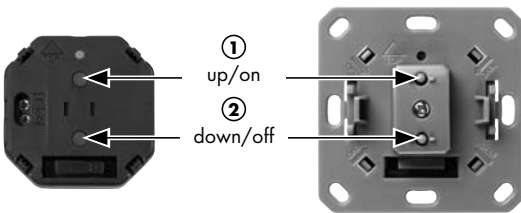

düwi wireless plug adaptor switch, art. no. 05437⁵
düwi wireless plug adaptor dimmer, art. no. 05439⁹

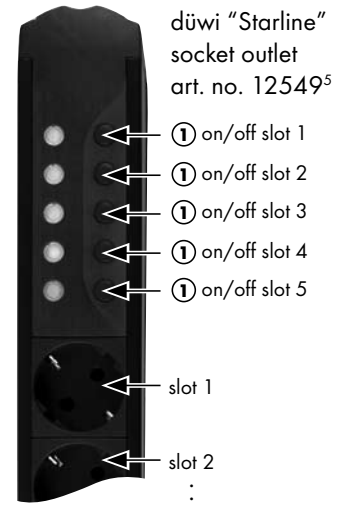
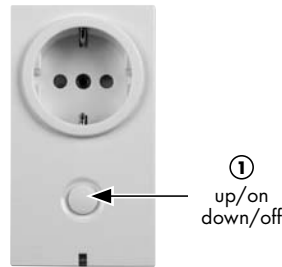

LED INDICATIONS

Due to the colour LED indication on transmitters and receivers it is possible at any time to obtain feedback on the success/failure of a switching command or a configuration step, to specifically enquire about the status of devices, or to monitor the switching status or the functionality of devices.

	Yellow	Device/group/scene is switched on
	Blue	Device/group/scene is switched off
	Red	Device/group/scene erroneous/configuration not successful/out of range
	Yellow flashing	Dimmer increasing brightness
	Blue flashing	Dimmer reducing brightness
	Green	Configuration successful
	Green flashing	Configuration active
	Red flashing	Low battery in the network/child protection active/temperature too high
	Red/Green	Device not programmed
	Red/Yellow/Green	Device not programmed

Combinations are possible within a group.



WIRELESS FLUSH MOUNTED SWITCH ZW ES 1000

GB

TECHNICAL DRAWINGS

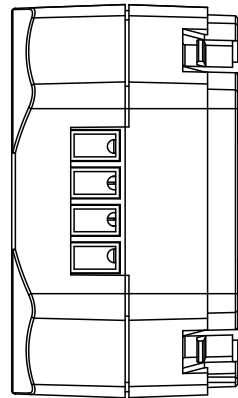
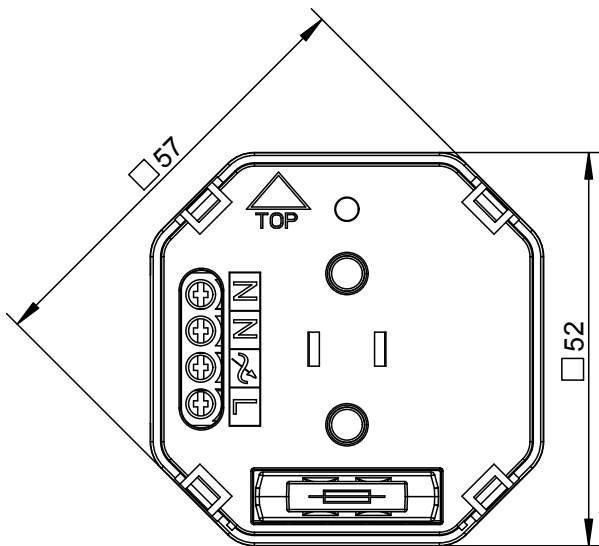
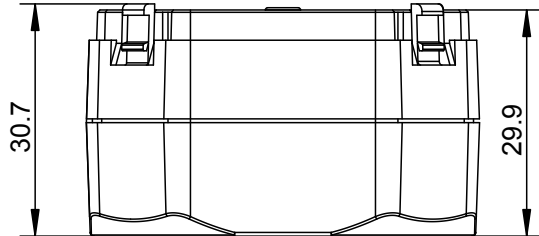

TECHNICAL DRAWINGS

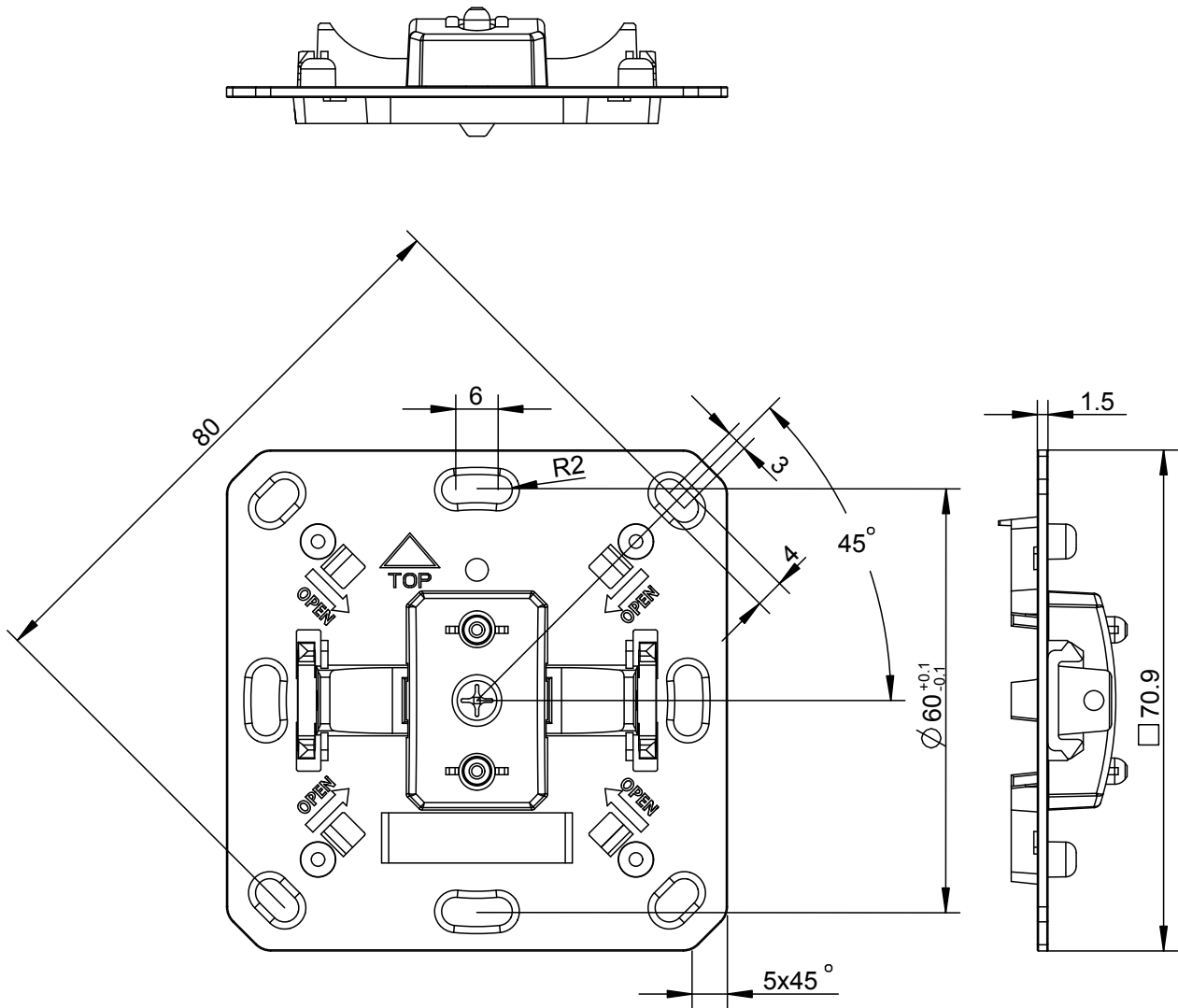

CONTENTS

	Page
1.0 The Z-Wave® wireless system	6
1.1 Information on the Z-Wave wireless system	6
1.2 Advantages of the Z-Wave wireless system	6
2.0 General notes	6
2.1 Correct use	6
2.2 General safety instructions	7
3.0 User manual	7
3.1 LED indications.....	8
3.1.1 Overview of LED indications on the devices.....	8
3.1.2 Advantages of the LED indications.....	8
3.1.3 Delivery state.....	8
3.2 Setting up a simple wireless network (without switching centre/server)	8
3.2.1 Including devices in a group/scene	8
3.2.2 Deleting/removing included devices.....	9
3.2.3 Checking the switching status (status enquiry)	9
3.3 Resetting system components/the system.....	9
3.3.1 Removing a device from the network.....	9
3.3.1 Removing an additional controller from the network	10
3.3.3 Deleting primary controller and network	10
3.3.4 Deleting wireless switching centre/server as primary controller and network.....	11
3.4 Expanded functions.....	11
3.4.1 Including devices in a scene.....	11
3.4.2 Activation of the All On/All Off functionality	12
3.4.3 Child protection function.....	12
3.5 Working with more than one controller	13
3.5.1 Including additional controllers.....	13
3.5.2 Synchronising additional controllers.....	13
3.5.3 Including devices on additional controllers	13
3.5.4 Allocating an included device to a group/scene.....	14
3.5.5 Connecting flush-mount modules	14
3.5.6 Connecting flush mounted modules or plug adaptors to a wall transmitter (without direct wireless connection)	15
3.6 Managing groups/scenes on the controllers.....	15
3.6.1 Removing devices from a group/scene - devices remain in the network.....	15
3.6.2 Deleting a complete group/scene - devices remain in the network.....	16
3.6.3 Removing a faulty or temporarily inactive device from a group/scene.....	16
3.7 Setting up a wireless network with a wireless switching centre/server	16
3.7.1 Integration of a wireless switching centre/server in an existing network.....	17
3.7.2 Setting up a new network using a wireless switching centre/server.....	17
4.0 Annex	18
4.1 Warranty	18
4.2 Disposal.....	18
4.3 Glossary.....	18

1.0 The Z-Wave® radio system

1.1 INFORMATION ON THE Z-WAVE RADIO SYSTEM

Z-Wave®

- Is an internationally established and defined standard for the control of wireless systems
- Is a professional, reliable and easy to operate wireless system on the interference-free frequency of 868.42 MHz
- Is future-proof and can be expanded step-by-step to form a complex system using the mutually compatible products from the Z-Wave Alliance



Products with this logo guarantee the best possible compatibility and ensure that Z-Wave products from other, well-known manufacturers are supported and can be integrated into existing systems.

Z-Wave® is a registered trademark of Zensys Inc. and its subsidiaries in the USA and other countries.

1.2 ADVANTAGES OF THE Z-WAVE WIRELESS SYSTEM

With the Z-Wave wireless system from düwi, which is based on international standards, you can conveniently and easily switch on and off your heating and air-conditioning system, electrical appliances or your entertainment electronics.

Z-Wave offers numerous advantages over conventional wireless systems: Due to a bidirectional wireless connection (command and reply are displayed) and the usage of multi-colour LEDs it is possible to enquire about the status of specific devices at any time (on/off/up/down/battery charge state) or to obtain feedback of the success/failure of switching commands or configuration steps.

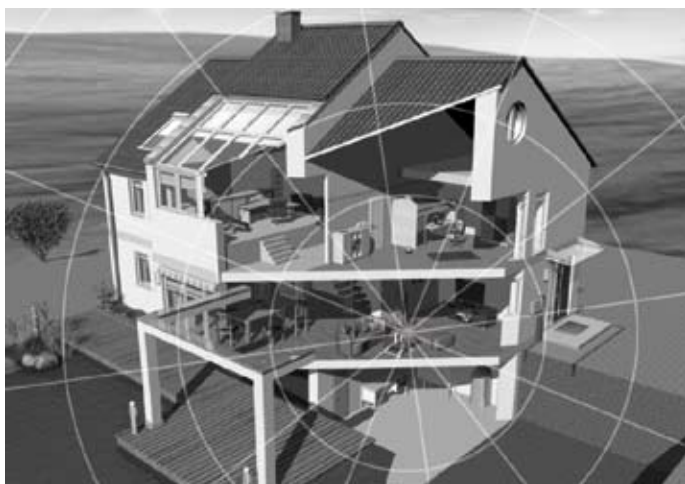

Z-Wave uses interacting network nodes. The individual receivers/appliances are connected together and therefore form a tightly meshed wireless network in which the signals are forwarded to the next, neighbouring receiver. Due to this forwarding function, individual devices act like amplifiers. It is therefore also possible to reach devices that are not within the immediate wireless range of the remote control (mesh-type network structure). As a result the system can also manage several, alternative connections between individual devices, the availability in the wireless network is thus significantly increased and the susceptibility to interference reduced.

2.0 General notes

2.1 CORRECT USE

All Z-Wave devices are only suitable for usage in dry rooms indoors. The wireless plug adaptor switch IP44 (art. no. 05438²) is also suitable for use outdoors.



All Z-Wave devices comply with the applicable European CE directives.

2.2 GENERAL SAFETY INSTRUCTIONS



Only authorised, suitably qualified personnel are allowed to work on 230 V mains taking into account national installation regulations/standards. Prior to installing the product, the mains supply is to be isolated and secured against unintentional switch on.

In the case of battery-operated devices, attention is to be paid to the correct polarity of the batteries on insertion.

- The product is only allowed to be used as intended (as described in the user manual). Any claims under the warranty will be rendered void if changes or modifications have been made, or the devices have been painted. The product must be immediately checked for damage on unpacking. In the event of damage, the product must not be placed in operation under any circumstances. If hazard-free operation of the product cannot be ensured, it must be unplugged or disconnected without delay and secured against unintentional operation.
- Do not switch any appliances that could cause injury/damage if switched on unintentionally (e.g. circular saws, life-support systems).
- Only switch appliances that are approved for operation at 230V/50Hz.
- Do not use wireless dimmers/switches for safety purposes (e.g. as an emergency stop or for making an emergency call).
- Only load wireless dimmers/switches to the stated maximum power.



The device is a wireless article with Z-Wave technology. If parts of this device do not work correctly, your safety will not be at risk, there will simply be a loss of function. In this case the devices can be switched manually by pressing the button.

3.0 User manual



düwi wireless remote control
art. no. 05445⁰

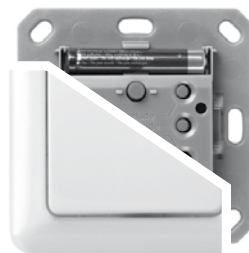

düwi wireless wall transmitter
art. no. 05443⁶



düwi wireless switching centre/server
art. no. 05447⁴



Every controller (e.g. remote control, wall transmitter or wireless switching centre/server) comes from the factory with a unique identification number (ID). When additional devices are included, this ID is provided to the other devices resulting in a coded, self-contained wireless network. This feature is advantageous if several households in the immediate vicinity use the same system, e.g. on housing estates, in semi-detached houses or terraced housing schemes.

3.1 LED INDICATIONS

3.1.1 Overview of LED indications on the devices

You will find an overview of the various LED indications on page 2.

3.1.2 Advantages of the LED indications

As a result of the colour LED indication on the transmitters and receivers it is at all times possible

- To obtain feedback on the success/failure of switching commands or configuration steps.
- To enquire about the status of devices (on/off/up/down/battery).
- To monitor the switching status and the functionality of devices that are outside the field of view or on other floors.

3.1.3 Delivery state

During commissioning or the first time a button is pressed, the delivery state (not programmed) of the devices is indicated by a red/green flashing LED.

3.2 SETTING UP A SIMPLE WIRELESS NETWORK (WITHOUT WIRELESS SWITCHING CENTRE/SERVER)





This section describes the commissioning of a simple network with the basic functions on the initial usage of only one controller (remote control or wall transmitter). For more extensive features, please see from section 3.4.



Please note that the controller (remote control, wall transmitter) that you activate first is the primary controller that allocates a unique, interference-free address or identification number (ID) to the entire wireless network. You can only add further devices to the network using this primary controller. In the case of loss or damage to the primary controller, the complete wireless network must be re-configured. We recommend the usage of a remote control or a wireless switching centre/server as the primary controller.

On the installation of more complex systems, e.g. on the usage of several controllers (remote controls/wall transmitters) we generally advise the usage of a wireless switching centre/server (art. no. 05447⁴). It simplifies operation during configuration, secures and co-ordinates the data in the wireless network, monitors the battery state of the devices and as a result reduces the battery usage of other controllers (remote controls/wall transmitters).

3.2.1 (Directly) including devices in a group/scene

Controller	LED	Receiver	LED
3x ▲/▼ 	 flashes green	3x ①/② 	 illuminates green

- Press 3x within 1.5 seconds the "UP" ▲ or "DOWN" ▼ button for the group on the remote control in which the device is to be included.
- The LED starts to flash green and permits the inclusion of devices for 15 seconds.
- In the case of a **plug adaptor** press 3x within 1.5 seconds the function button (①); during this process the device retains its last switching status ("on" or "off").
- In the case of a **flush mounted module** press 3x within 1.5 seconds either the "UP" ① or "DOWN" ② button. During this process you can choose whether the device and any connected neighbouring devices switch on (by pressing the "UP" ① button) or switch off (by pressing the "DOWN" ② button).

Both controller and target device indicate successful inclusion for 3 seconds with a green LED indication, failed inclusion with a red LED indication. The device is now allocated directly to the required group. Repeat the procedure to include additional devices.

In general you can allocate a device to one or more different groups (e.g. a standard lamp can be switched in group "1" with the dining room lighting and in group "2" with the living room lighting).

3.2.2 Deleting/removing included devices

You can undo the inclusion of devices by:

- Removing the devices from a group/scene (the device remains in the network, disassociation see 3.6.1).
- Removing a device from the network (Reset device or Exclude device from the network, see 3.3.1).
- Deleting a complete group/scene (devices remain in the network, disassociation, see 3.6.2).
- Completely resetting the system (see 3.3.1 – 3.3.4).

3.2.3 Checking the switching status (status enquiry)





Controller	LED
	indicates status (see page 2)

- By pressing the related middle button **E** on the remote control you can display the switching status of a group on the LED indicator on the remote control (LED indications on the cover, page 1).
- To enquire about the switching status of the entire network, press the middle button in the "All On/Off" group for 2 seconds until the LED flashes green briefly.
- Then an enquiry about the switching status of all devices in the network is sent and the status indicated.

3.3 RESETTING SYSTEM COMPONENTS/THE SYSTEM

Resetting all system components to the delivery state or a complete network reset is to be undertaken as follows; the scope of the reset increases step-by-step in the following sections.

3.3.1 Removing a device from the network (Reset or Exclude device from the network)

Controller	LED	Receiver	LED
	 flashes green		 illuminates grün





- To remove a device you can use any controller (remote control, wall transmitter or wireless switching centre/server)
- Press for 2 seconds the "Exclude" **E** button on the controller.
- The LED starts to flash green and permits the removal of devices for 15 seconds.
- In the case of a **plug adaptor** press 3x within 1.5 seconds the function button (①), during this process the device retains its last switching status ("on" or "off").
- In the case of a **flush mounted module** press 3x within 1.5 seconds either the "UP" ① or the "DOWN" ② button. During this process you can choose whether the device and any connected neighbouring devices switch on (by pressing the "UP" ① button) or switch off (by pressing the "DOWN" ② button).

Both controller and target device indicate successful removal for 3 seconds with a green LED indication, failed removal with a red LED indication.

After successful removal, the device is in the delivery state again.

3.3.2 Removing an additional controller from the network (e.g. resetting remote control or wall transmitter)

If you do not want to reset the complete network, but just one controller (remote control or wall transmitter), proceed as follows:

Controller 1	LED	Controller 2	LED
	 flashes green		 illuminates green







- Press the "Exclude" **E** button on your primary controller for 2 seconds (any controller in network with wireless switching centre/server).
- The LED starts to flash green and permits the removal of the controller for 15 seconds.
- Press for 2 seconds the "Include" **I** button on the controller you want to remove.

Both controllers indicate successful resetting for 3 seconds with a green LED indication, failed resetting with a red LED indication.

After successful resetting, the device is in the delivery state again.

3.3.3 Deleting primary controller and network

If you have a network without a wireless switching centre/server, the complete network can be deleted with the following steps. For a system with a wireless switching centre/server, for resetting see 3.3.4.



Controller	LED	Controller	LED	Controller	LED
	 flashes green ...		 ... flashes red/yellow/green		 illuminates green

- Press the "Exclude" **E** button on the controller for 5 seconds.
- The LED starts to flash green and changes to red/yellow/green flashing
- Press 3x within 1.5 seconds the "All On" **On** button (on a remote control) or "UP" **▲** button (on a wall transmitter).
- Press 3x within 1.5 seconds the "All Off" **Off** button (on a remote control) or "DOWN" **▼** button (on a wall transmitter).
- The LED starts to flash green quickly.

Successful deletion is indicated for 3 seconds with a green LED indication, failed deletion with a red LED indication.

3.3.4 Deleting wireless switching centre/server as primary controller and network

If you have a wireless switching centre/server as the primary controller in the network, the network data are deleted as follows:

Controller	LED
 10 sec. I + E + A	 flashes red/yellow/ green

- Press simultaneously for 10 seconds the "Include"**I** + "Exclude"**E** + "Associate"**A** buttons on the controller.





A successful reset is indicated by red/yellow/green flashing of the status LED.

3.4 EXPANDED FUNCTIONS

Along with the basic functions already described, other configurations are possible.

3.4.1 (Directly) including devices in a scene

A scene makes it possible for you to switch devices to a pre-programmed, defined value and thus to realise various light, switch or mood scenarios (e.g. shutter half way down and lights dimmed to 60% in the evening for watching television).

Controller	LED	Receiver	LED
 3x ▲/▼	 flashes green	 3x ①/②	 illuminates green



- Press 3x within 1.5 seconds the "UP"**▲** or "DOWN"**▼** button for the required scene on the remote control in which the device is to be included.
- The LED starts to flash green and permits the inclusion of devices for 15 seconds.
- Place the device in the required switching status or to the required brightness.
- In the case of a **plug adaptor** press 3x within 1.5 seconds the function button (①). During this process the device will retain its last switching status and brightness setting.
- In the case of a **flush mounted module** press 3x within 1.5 seconds either the "UP"**①** or "DOWN"**②** function button.
 During this process you can choose whether the device then switches on (by pressing the "UP"**①** button) or switches off (by pressing the "DOWN"**②** button).

Both controller and target device indicate successful inclusion for 3 seconds with a green LED indication, failed inclusion with a red LED indication.

The device is now allocated to the required scene and on the activation of the related scene will be placed directly in the programmed switching status or to the programmed brightness.

3.4.2 Activation of the All On/All Off functionality

To be able switch devices from different groups or scenes simultaneously (e.g. switching off all appliances on leaving the housing or switching on all lights in case of danger), these devices can be specifically allocated to the All On/Off group on the remote control or a wall transmitter.

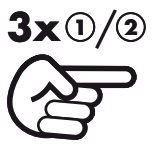
Remote control		Receiver
		





- Press simultaneously for 2 seconds the "Include" **I** and "Associate" **A** buttons on the rear of the remote control.
- On the front, in the "All On/Off" group, press one of the following buttons:
 - "On" **On**, to add the device to the All On group
 - "Off" **Off**, to add the device to the All Off group
 - "On" **On** and "Off" **Off** together to add the device to the All On/Off group
 - "Status" **S**, to remove the device from the All On/Off group.
- In the case of a **plug adaptor** press 3x within 1.5 seconds the function button (1), during this process the device retains its last switch state ("on" or "off").
- In the case of a **flush mounted module** press 3x within 1.5 seconds either the "UP" (1) or "DOWN" (2) function button.

During this process you can choose whether the device and any connected neighbouring devices then switch on (by pressing the "UP" (1) button) or switch off (by pressing the "DOWN" (2) button).
- In the case of a **wall transmitter** press 3x within 1.5 seconds either the "UP" (1) or "DOWN" (2) function button.

During this process you can choose whether the devices and any connected neighbouring devices then switch on (by pressing the "UP" (1) button) or switch off (by pressing the "DOWN" (2) button).

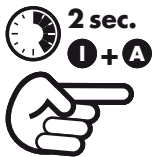
3.4.3 Child protection function

In the case of the child protection function you can select whether it is to be possible to operate a device only after manual "unlocking" via the buttons (sequence protection) or in general the device can only be operated wirelessly.

Controller	LED	Controller	Receiver
			

- Press simultaneously for 2 seconds the "Include" **I** and "Associate" **A** buttons on the controller until the LED flashes green.
- Select the required type of protection as follows.
 - Group 1 "UP" (1) button to deactivate the child protection
 - Group 1 "Status" **S** button to activate the sequence protection
 - Group 1 "DOWN" (2) button to be only able to operate the device wirelessly
- In the case of a **plug adaptor** press 3x within 1.5 seconds the function button (1), during this process you can select whether the device is to be switched on or switched off.
- In the case of a **flush mounted module** press 3x within 1.5 seconds either the "UP" (1) or "DOWN" (2) function button.





During this process you can choose whether the device and any connected neighbouring devices then switch on (by pressing the "UP" (1) button) or switch off (by pressing the "DOWN" (2) button).

In the case of the "Sequence" type of protection, the device can be unlocked briefly by pressing 3x the function buttons (①/②), the LED indication illuminates green if successful. 5 seconds after the last button press the device is protected again automatically, the LED indication flashes red during this process.

3.5 WORKING WITH MORE THAN ONE CONTROLLER

3.5.1 Including additional controllers (wall transmitter, remote control) Include and Replication

During this process an additional controller is included in the network using the primary controller (or in the case of the usage of a wireless switching centre/server using any controller)

Controller 1	LED	Controller 2	LED	LED
 3x ①	 flashes green	 2 sec. ①	 flashes green	 illuminates green

- Press 3x the "Include" ① button on your primary controller (any controller in network with wireless switching centre/server).
- The LED starts to flash green for 15 seconds.
- Press for 2 seconds the "Include" ① button on the controller you want to include.
- The LED starts to flash green.
- As soon as the inclusion (and update) of the additional controller starts, the frequency at which the LEDs on both controllers flash increases.





Successful inclusion of the additional controller is indicated for 3 seconds with a green LED indication on both devices, failed inclusion with a red LED indication.

3.5.2 Synchronising additional controllers (in the case of network without wireless switching centre/server)

As initially only the primary controller has the current network data, it is sensible to synchronise all controllers to ensure the stable function of the network. To synchronise, repeat the the inclusion process from point 3.5.1 for each controller you want to update.

3.5.3 Including devices on additional controllers

Here a device is registered in the network using the primary controller (or on the usage of a wireless switching centre/server using any controller), without direct allocation to a group. The device can then also be allocated to the group/scene on other controllers in the network, e.g. an additional wall transmitter or if the device is not to be switched via the primary controller.





Controller	LED	Receiver	LED
 3x ①	 flashes green	 3x ①/②	 illuminates green

- Press 3x the "Include" ① button on your primary controller (any controller in network with wireless switching centre/server).
- The LED starts to flash green and permits the inclusion of devices for 15 seconds.
- In the case of a **plug adaptor** press 3x within 1.5 seconds the function button (①), during this process the device retains its last switching status.
- In the case of a **flush mounted module** press 3x within 1.5 seconds either the "UP" ① or the "DOWN" ② button. During this process you can choose whether the device and any connected neighbouring devices then switch on (by pressing the "UP" ① button) or switch off (by pressing the "DOWN" ② button).

Both controller and target device indicate successful inclusion for 3 seconds with a green LED indication, failed inclusion with a red LED indication.

3.5.4 Allocating an already included device to any group/scene

(If the device is to be allocated to a scene with a defined nominal state, e.g. with a specific brightness, set to device to this state by pressing the related function button (①/②).)

Controller	LED	Receiver	LED
3x ▲/▼ 	 flashes green	3x ①/② 	 illuminates grün







- Press 3x within 1.5 seconds on the required controller the "UP" ▲ or "DOWN" ▼ button for the required group/scene.
- The LED starts to flash green and permits the allocation of devices for a period of 15 seconds.
- Press 3x within 1.5 seconds a function button (①/②) on the receiving device (e.g. plug adaptor, flush mounted module).

Both controller and receiving device indicate successful allocation for 3 seconds with a green LED indication, failed allocation with a red LED indication.

The device is now allocated directly to the related group.

3.5.5 Connecting flush-mount modules

The flush mounted modules make it possible to connect up to four devices, e.g. to simultaneously switch or dim several devices simultaneously.

Controller		Receiver	Controller	LED
 2 sec. 	1x ① 	3x ①/② 	3x ▲/▼ 	 illuminates green











- Press for 2 seconds the "Associate" Ⓐ button on the controller of your choice.
- Briefly press the "Include" ① button on the same controller.
- Press 3x within 1.5 seconds either the "UP" ① or "DOWN" ② button on the receiving device (this device is controlled by the connected device).
- Press 3x within 1.5 seconds either the "UP" ▲ or "DOWN" ▼ button on the controller (this device controls the connected device).







The controller indicates successful connection for 3 seconds with a green LED indication, failed connection with a red LED indication.

To be able also to switch the devices both ways, repeat the above procedure with the order reversed.

3.5.6 Connecting flush mounted modules or plug adaptors with a wall transmitter (if there is no direct wireless connection)

If you want to connect a wall transmitter with a flush mounted module in the network that cannot be reached directly from a wall transmitter already installed, proceed as follows

Controller		Receiver	Controller 2
 2 sec. 	1x 	3x  / 	3x  / 
			











- Press for 2 seconds the "Associate"  button on the controller.
- Briefly press the "Include"  button on the controller.
- Press 3x within 1.5 seconds either the "UP"  or "DOWN"  button on the receiving device.
- Press 3x within 3 seconds the function button ( / ) on the receiving device.





Please note that to operate the device at least one device that supports routing (plug adaptor, flush mounted module, wireless switching centre/server) is required to establish a connection between the wall transmitter and the device.

3.6 MANAGING GROUPS/SCENES ON THE CONTROLLERS

It is possible at any time to change the membership (allocation) of device in groups/scenes, e.g. to add or remove individual devices from a group/scene or to reset entire groups/scenes.

3.6.1 Removing devices from a group/scene – devices remain in the network (Disassociation)





Controller	LED	Controller	LED	Receiver	LED
 2 sec. 	 flashes green (quickly)	1x 	 flashes green (slowly)	3x  / 	 illuminates green
					

- Press the "Associate"  button on the related controller for 2 seconds (remote control/wall transmitter).
- The LED starts to flash green (quickly).
- Press the "DOWN"  button on the controller for the related group/scene.
- The LED starts to flash green (slowly)
- In the case of a **plug adaptor** press 3x within 1.5 seconds the function button .
- In the case of a **flush mounted module** press 3x within 1.5 seconds either the "UP"  or "DOWN"  function button.

The receiving device indicates successful removal for 3 seconds with a green LED indication, failed removal with a red LED indication.

The device has been removed from the group/scene and will no longer be operated or displayed.

3.6.2 Deleting a complete group/scene – devices remain in the network (Disassociation)

Controller	LED	Controller	LED
			



- Press the "Associate" **A** button on the related controller for 10 seconds (remote control/wall transmitter).
- The LED starts to flash red/yellow/green.
- Press the "DOWN" **▼** button on the controller for the related group/scene.

The controller signals successful deletion of a group/scene for 3 seconds with a green LED indication, failed deletion with a red LED indication.

The group/scene is now blank and can be configured again.

3.6.3 Removing a faulty or temporarily inactive device from a group/scene

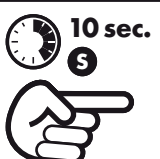
If a device in a group/scene is faulty or is to be temporarily set inactive (e.g. if a plug adaptor has been removed) and can therefore no longer be reached, after an attempt at switching or enquiring about the status the message "Device faulty" is returned. This error message can be suppressed by automatic deactivation of the device. If this device is reactivated (e.g. if a plug adaptor is plugged in again), it is automatically reallocated to the original group/scene.

Controller	LED
	

- Press for 10 seconds the "Status" **S** button for the related group/scene on the controller, if you want to clear the status indication for a group.
- Press for 10 seconds the "Status" **S** button for the "All On/Off" group on the controller, if you want to clear the complete network (e.g. in the case of the loss or destruction of a device)

The controller indicates successful clearing of the status indication for a group or the network for 3 seconds with a green LED indication, failed clearing with a red LED indication.

3.7 SETTING UP A WIRELESS NETWORK WITH WIRELESS SWITCHING CENTRE/SERVER





On the installation of more complex systems, e.g. on the usage of several controllers (remote controls/wall transmitters) we generally advise the usage of a wireless switching centre/server (art. no. 05447⁴). It simplifies operation during configuration, secures and co-ordinates the data in the wireless network, monitors the battery state of the devices and as a result reduces the battery usage of other controllers (remote controls/wall transmitters).



In general it is possible at any time to expand an existing network with a wireless switching centre/server.

In a network with a wireless switching centre/server, it is possible to include devices in the network or remove devices from the network using any controller.

3.7.1 Inclusion of a wireless switching centre/server in an existing network





First include the wireless switching centre/server in the current primary controller:



Controller	LED	Switching server	LED
3x 0 	 flashes green	 2 sec. 	 illuminates green

- Press 3x the "Include"  button on the primary controller.
- The LED starts to flash green and permits the inclusion of the wireless switching centre/server for 15 seconds.
- Press for 2 seconds the "Include"  button on the wireless switching centre/server.

Wireless switching centre/server and controller indicate successful inclusion for 3 seconds with a green LED indication, failed inclusion with a red LED indication.

Next include in succession all other controllers (remote control, wall transmitter) and battery-operated devices that were already in the network and that were not previously known to the wireless switching centre/server.





Switching server	LED	Controller	LED
3x 0 	 flashes grün	 2 sec. 	 illuminates grün



- Press 3x the "Include"  button on the wireless switching centre/server.
- The LED starts to flash green and permits the re-inclusion of the controller for 15 seconds.
- Press for 2 seconds the "Include"  button on the controller.

Wireless switching centre/server and controller indicate successful inclusion for 3 seconds with a green LED indication, failed inclusion with a red LED indication.

3.7.2 Setting up a new network using a wireless switching centre/server

First ensure all devices and controllers are in the initial state (red/green flashing LED) – see 3.3.1 (Reset device).

Switching server	LED	Controller	LED
3x 0 	 flashes grün	 2 sec. 	 illuminates grün

- Press 3x the "Include"  button on the wireless switching centre/server.
- The LED starts to flash green and permits the inclusion of the wireless switching centre/server for 15 seconds.
- Press for 2 seconds the "Include"  button on the controller.

Wireless switching centre/server and controller indicate successful inclusion for 3 seconds with a green LED indication, failed inclusion with a red LED indication.

Repeat the process with each additional controller that you want to add to the network. You can now include additional devices in the network or allocate them to groups and scenes at any time with any included controller.

4.0 Annex

4.1 WARRANTY

Claims under the warranty are subject to statutory provisions. Subject to technical change without notice.

- Our products are manufactured using the latest technology and are subject to strict quality control. Should, nevertheless, defects occur on your device, düwi GmbH provides a warranty as detailed below.
- Our warranty covers the improvement or delivery of a new device if the device can be demonstrated to be defective in relation to its function or the characteristics of the materials used.
- The warranty does neither cover natural wear and tear or transport damage, nor damage as a consequence of failure to follow the installation instructions or improper installation.
- The warranty is automatically rendered void if the device has been opened after fault diagnostics.
- The duration of the warranty is 24 months from the date of purchase of the device by the end user. Proof of purchase by means of a bill, delivery note or similar documentation is required to prove that the warranty period has not expired.
- Batteries, lamps and rechargeable batteries supplied are excluded from the warranty.
- düwi GmbH is not liable for indirect or consequential damage, or financial losses.

4.2 DISPOSAL



Within the EU this symbol indicates that this product is not allowed to be disposed of in household waste. Waste devices contain valuable materials that can be recycled and that should be sent for recycling to prevent pollution or a health hazard due to the uncontrolled disposal of waste.

For this reason please dispose of waste devices via suitable collection systems or send the device to the place you bought it for disposal. The device will then be sent for recycling.

4.3 GLOSSARY

Include	Include devices in a group/scene.
Exclude	Remove a device from the network
Associate	Connect (up to four) devices together so that, e.g., several devices can be switched or dimmed synchronously and simultaneously
Disassociate	Delete a complete group/scene, devices remain in the network
Reset	Reset a device or the system components to the delivery state (not programmed)
Replication	Copy the current network data to a further controller (remote control/wall transmitter/wireless switching centre/server)

Notes on programming compatible devices from the Z-Wave Alliance from other manufacturers:

Establish include mode	Press 3x the "Include" button on the controller
Establish exclude mode	Press for 2 seconds the "Exclude" button on the controller
Associate	For 2 seconds press "Associate" button on the controller, then the "UP" button on the controller followed by "Send Node Info Frame" on the target device
Reinclude/ Replicate	Press 3x the "Include" button on the controller followed by "Send Node Info Frame" on the target device
Disassociate	For 2 seconds press "Associate" button the controller, then the "DOWN" button on the controller followed by "Send Node Info Frame" on the target device
Learn Mode	Press 3x "UP" or "DOWN" button
Send Node Info Frame	(Slave) Press 3x "UP" or "DOWN" button (controller) for 2 seconds. Press "Include" button
Add Node	Press 3x "UP" or "DOWN" button (inclusion or primary controller)